

wer_analysis_on_inclined_screw _conveyor_using_DEM_simulati on.pdf *by*

Submission date: 04-May-2023 01:11PM (UTC+0700)

Submission ID: 2083831405

File name: wer_analysis_on_inclined_screw_conveyor_using_DEM_simulation.pdf (703.37K)

Word count: 2325

Character count: 11357



Capacity and power analysis on inclined screw conveyor using DEM simulation

Ahmad Faishol¹, Mulyadi², Edi Widodo³

¹Mechanical Engineering, Universitas Muhammadiyah Sidoarjo
Jl. Raya Gelam No. 250, Candi, Sidoarjo, Indonesia
e-mail: mulyadi@umsida.ac.id

Abstract

DEM is a method based on the theory of molecular dynamics that can simulate the movement of granular materials. One of the advantages of this method is it can simulate accurately without creating a real object. This study aims to determine how much influence the inclination of the screw conveyor has on the capacity and power of the motor. Corn shelled was used as a test with continuous filling of 1000 ft³/hour for 20 seconds, while modeling by screw conveyor 2 meter long at positions 0°, 20° and 45° with variations in speed of 50 rpm, 75 rpm and 100 rpm. Screw conveyor mass flow and torque data are taken for analysis. The DEM simulation results at a speed of 100 rpm with inclination of 0° is 21,2 ton/hour and the required power of 1.58 HP. Different results are obtained in modeling with an inclination of 45°, the capacity drops to 8,6 ton/hour with the required power of 11.8 HP. It can be seen that the capacity reduction due to inclination reaches more than 50% with a significant increase in power.

Keywords: Discrete Element Method (DEM); CEMA; Bulk Material; Rpm

1. INTRODUCTION

Screw conveyor is one of bulk materials conveying that is capable of handling various kinds of materials with relatively good flowability (1). Screw conveyors are widely used to transport bulk materials in industries ranging from chemicals, cement, mineral industries, and food processing (2). The screw conveyor consists of a pipe as the main shaft with a plate formed into continuous helix which is welded to the main shaft (3). The main shaft will be rotated by the drive so that the screw plate or so-called flight will also rotate. The rotation of this screw plate will push the bulk material (4). Apart from planning, there are several factors that can affect the capacity of the screw conveyor, one of which is the inclination of the conveyor (5). Large inclinations will be followed by reduced capacity (6). Planning before the manufacturing process is very important to produce the expected performance. One part of the planning is simulation to find out conveyor performance without expensive real manufacture.

DEM (Discrete Element Method) software has the ability to simulate flow in a screw conveyor by entering required parameters (7). EDEM™ is a DEM simulation software platform designed for the simulation and analysis of bulk material handling and processing operations (8). EDEM can quickly and easily model the parameters of a bulk solids system. EDEM manages information about each particle (mass, velocity, force and so on) and the forces acting on it and can also take into account the shape of the particle, rather than assuming that all particles are spherical. For post-processing, EDEM provides data analysis tools, 3D particle flow visualization and video making (9).

The purpose of this study is to determine the performance of the screw conveyor when it is in an inclined position, especially the performance of capacity and motor power. The results obtained from this research can be a reference in screw conveyor design to obtain more accurate performance.

2. METHODS

The method used in this study is a computational experiment with a screw conveyor design referring to the CEMA standard. Meanwhile, the simulation uses EDEM software version 2021. For computing, use a PC with Intel® Core™ i3-9100F CPU @ 3.60GHz, 8GB RAM, Graphics Processor using AMD Radeon 4GB. Modeling was carried out at positions 0°, 20° and 45°, with variations in speed of 50 Rpm, 75 Rpm and 100 Rpm respectively. The results of the simulation were analyzed to find out how much the inclination affects the capacity and power on the screw conveyor. The simulation data is presented in the form of graphs for analysis of the results.

The screw conveyor modeling for this experiment uses the following parameters.

Table 1. Modeling Parameter

Parameter	Value
Design Capacity	1000 ft3/hr (21 TPH)
Screw Diameter	12 inch
Pitch	6 inch
Screw Length	6,5 feet
Speed (rpm)	50, 75, 100
Inclination	0°, 20°, 45°
Bulk Material	Corn shelled

Due to the limited three-dimensional modeling capabilities of the EDEM software, three-dimensional modeling was done by Solidworks, which mainly includes three parts, feed area, screw and housing, as shown in Figure 1.

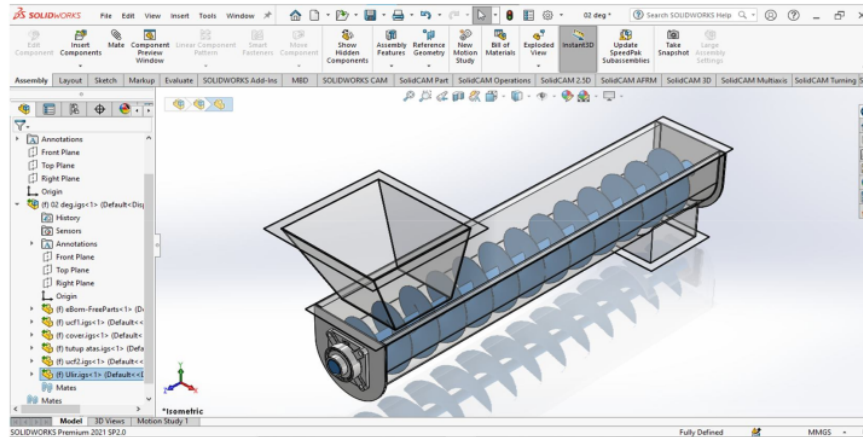

Figure 1. 3D Model of Screw Conveyor

The bulk material particle size is determined to minimize the simulation error and obtain a reasonable and effective simulation time. For this experiment, determine that the bulk material is corn shelled. Parameters and the values are shown in Table 2

Table 2. Parameter of Corn Shelled (10).

Parameter	Value
Particle length (mm), l	12.57
Particle width (mm), w	7.99
Particle thickness (mm), h	4.89
Particle equivalent diameter (mm), de	8.0
Particle radius (mm), re	4.0
Particle mass (mg), m	250-349.7

Bulk density (kg m ⁻³), ρ_b	721
Particle Poisson ratio, ν	0.32
Particle elastic modulus (MPa), E	10.9-2320
Particle shear modulus (MPa), G	23
Particle static friction coefficient, μ_s (With steel or stainless steel)	0.12
Bulk angle of repose ($^\circ$)	16
Dynamic angle	23.1-34.7

In the pre-processing setting, the particle model adopts the corn shelled model, with the particle generation mode being dynamic, and material with a mass of 6 kg/s (21,6 t/hr) generated by fast filling with a simulation time of 20 seconds.

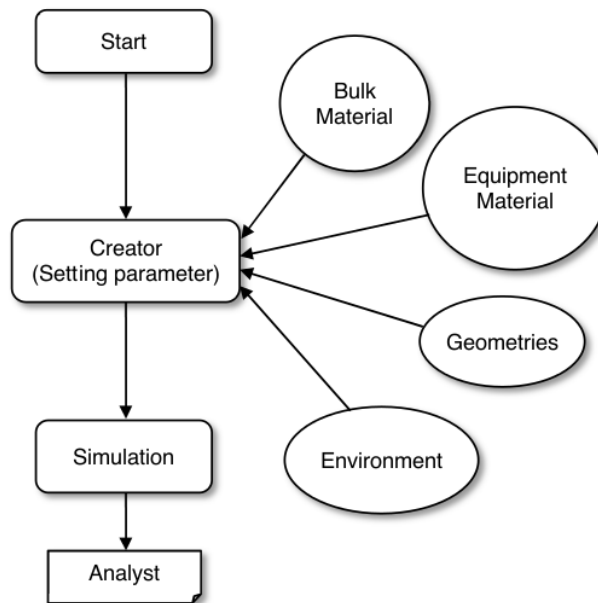

Figure 2. Flow chart EDEM Simulation

3. RESULT AND DISCUSSION

In the DEM simulation, the mass flow sensor is positioned at the screw conveyor outlet, then the average value is taken and converted to capacity per hour. While the power is obtained from the highest torque value during the simulation then it is calculated to get the power value in Horsepower (HP).

The simulation results with several variations of the test are then entered in Table 3

Table 3. Screw conveyor simulation results with various variations

S/N	1	2	3	4	5	6	7	8	9
Inclination	0 ^o	0 ^o	0 ^o	20 ^o	20 ^o	20 ^o	45 ^o	45 ^o	45 ^o
Speed (rpm)	50	75	100	50	75	100	50	75	100
Capacity (t/hr)	12,2	19,2	21,2	10,3	9,8	9,1	1,8	7,6	8,6
Power (HP)	0,94	1,21	1,58	1,13	2,28	1,81	1,09	2,26	11,8

From the simulations by EDEM, it can be seen the flow rate in the material flow process and the required power in real time. The resulting capacity and the required power at the inclination position are shown in the following figure.

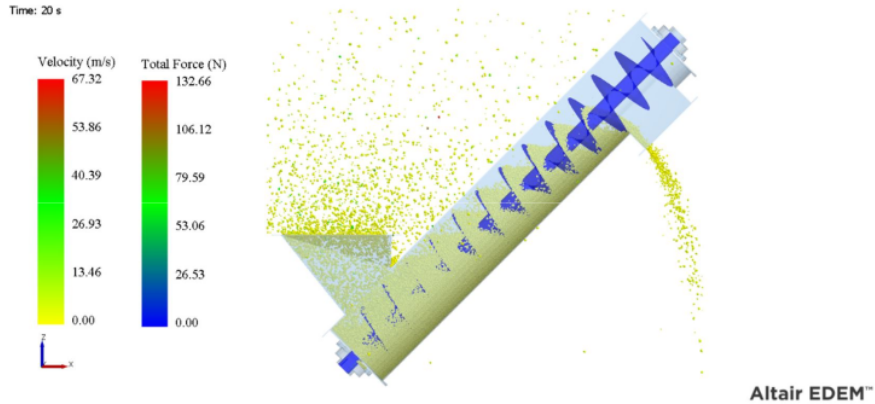
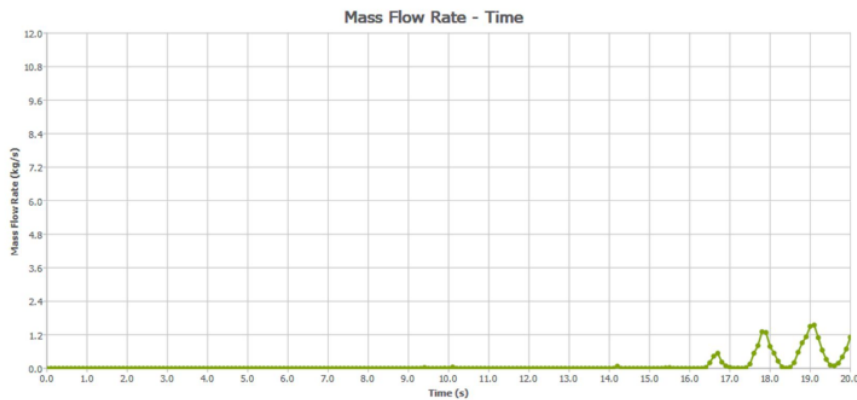
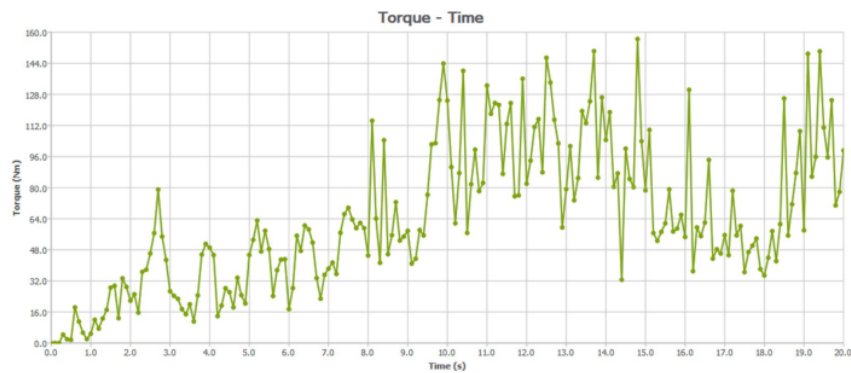

Figure 3. Simulation on 45 Degree modeling with 50 Rpm



Graphic 1. Mass flow simulation results of 45 degrees on 50 Rpm



Graphic 2. Torque simulation results of 45 degrees on 50 Rpm

The capacity for the degree of inclination and the speed of the screw conveyor is shown in graphic 3, while the power required for the degree of inclination and the speed of the screw conveyor is shown in graphic 4.

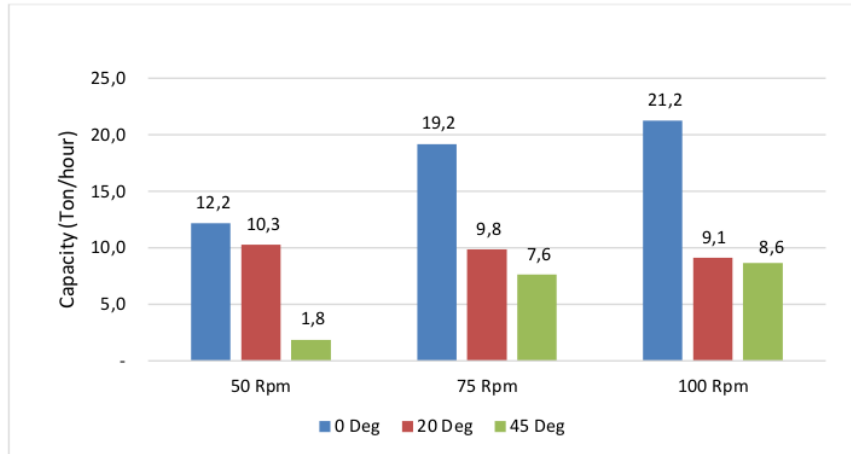

Graphic 3. DEM Simulation results for capacity

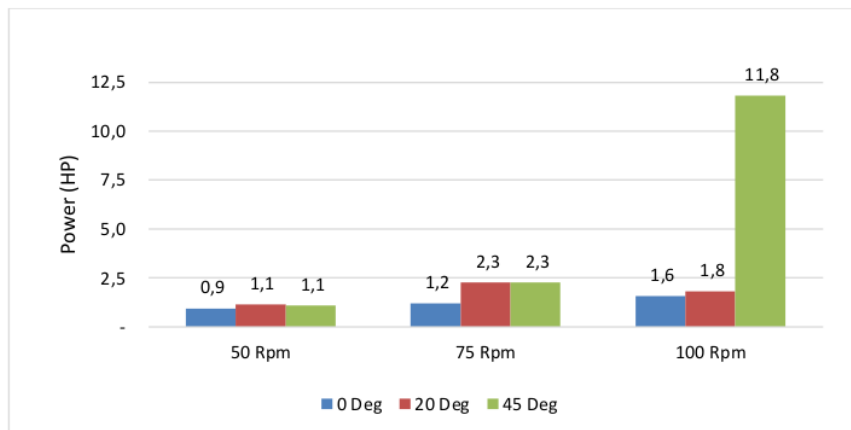

Graphic 4. DEM Simulation results for horsepower

The largest capacity obtained from nine DEM simulations is the screw conveyor with an inclination of 0° at 100 rpm, and the required motor power is 1.58 HP. While the smallest capacity is on the screw conveyor with an inclination of 45° at 50 rpm, and the required motor power is 1.1 HP.

It can also be seen that the screw conveyor with the same filling capacity, at an inclination of 0° with 100 rpm can produce a capacity of 21,2 t/hr. Different results were obtained when the screw conveyor was positioned at an inclination of 45° at the same rotation resulting in a capacity of 8,6 t/hr, or there was a decrease in capacity of around 60%.

From research by Volodymyr Bulgakov et al. in the journal INMATEH-Agriculture Engineering Vol. 67, No. 2 of 2022, states that at 300 rpm rotation with an inclination of 30° , the capacity will decrease between 45% to 50% (11).

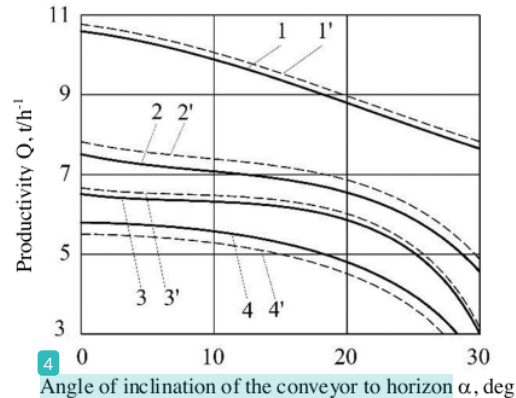

Graphic 5. Productivity Q of the conveyor with a screw working body (solid line) and bladed one (dashed line) at 300 rpm (1 – sand; 2 – peas; 3 – wheat; 4 – corn).

Even though the value of decrease is different, the two experiments have the same conclusion, there is a significant decreasing in capacity caused by the inclination of the screw conveyor. The difference in the value of this decrease occurs due to using different methods and different rotation speeds and degrees of inclination. The advantage of the DEM method is its ability to analyze every particle movement and its interactions without making a screw conveyor on a real manufacture.

The decrease in capacity and the increase in power at the inclination position occur as a result of fall back or falling back of bulk material and the effect of gravity. This is in accordance with KWS Manufacturing's explanation in his book *Screw Conveyor Engineering Guide*, 2015.

The results of this experiment show that the slope or inclination of the screw conveyor has a large effect on decreasing capacity and increasing motor power, therefore inclination is one of the important factors in design a screw conveyor.

4. CONCLUSION

Based on the previous literature, the DEM simulation and actual experiments have almost the same results. Simulation using DEM will minimize the cost of making real conveyors with the same accuracy of simulation results.

An increase in inclination will be accompanied by a decrease in transport efficiency and an increase in the power required to overcome gravity and falling bulk material. Reduced transport efficiency due to inclination can be overcome by increasing the screw conveyor speed.

Screw conveyors with an inclined position cause some of the bulk material to fall backwards causing loading to become overloaded. Screw conveyors with an inclined position must be designed taking these conditions by increasing the motor power.

REFERENCES

1. Bortolamasi M. DESIGN AND SIZING OF SCREW FEEDERS By Marco Bortolamasi Johannes Fottner. Technology. 2001;(March):27–9.
2. Patinge S, Prasad K. Screw feeder performance prediction using Discrete Element Method (DEM). 2017;8(3).
3. Bucklin R, Thompson S, Montross M, Abdel-Hadi A. Grain Storage Systems Design. Handbook of Farm, Dairy and Food Machinery Engineering: Second Edition. Elsevier Inc.; 2013. 123–175 p. doi: <https://doi.org/10.1016/B978-0-12-385881-8.00007-0>
4. Olanrewaju TO, Jeremiah IM, Onyeonula PE. Design and fabrication of a screw conveyor. Agric Eng Int CIGR J. 2017;19(3):156–62.
5. Nicolai R, Ollerich J, Kelley J. Screw auger power and throughput analysis. ASAE Annu Int Meet 2004. 2004; 7133–41. doi: <https://doi.org/10.13031/2013.16981>

6. KWS. Screw_conveyors. 2015; <https://www.kwsfmfg.com/wp-content/themes/va/pdf/Screw-Conveyor-Engineering-Guide.pdf>
7. Mousaviraad M, Tekeste M, Rosentrater K. Discrete element method (DEM) simulation of corn grain flow in commercial screw auger. 2016 Am Soc Agric Biol Eng Annu Int Meet ASABE 2016. 2016; doi: <https://doi.org/10.13031/aim.20162462358>
8. Fang XG, Chen YH, Liu WF, Luo XR, Xie GJ. Application of discrete element method in the analysis of loader shovel loading process. *Curr Trends Comput Sci Mech Autom.* 2018;2:239–49. doi: <https://doi.org/10.1515/9783110584998-027>
9. Guide EU. EDEM 2.4 User Guide. 2007;134.
10. Boac JM, Casada ME, Maghirang RG, Harner JP. Material and interaction properties of selected grains and oilseeds for modeling discrete particles. *Trans ASABE.* 2010;53(4):1201–16. doi: <https://doi.org/10.13031/2013.28840>
11. BULGAKOV V, TROKHANIAK O, HOLOVACH I, ADAMCHUK V, KLENDII M, IVANOV S. Investigation of the Performance of a Screw Conveyor With a Working Body, Made in the Form of a Shaft With Inclined Flat Blades. *INMATEH Agric Eng.* 2022;67(2):406–11. doi: <https://doi.org/10.35633/inmateh-67-41>

ORIGINALITY REPORT

19%

SIMILARITY INDEX

13%

INTERNET SOURCES

10%

PUBLICATIONS

8%

STUDENT PAPERS

PRIMARY SOURCES

1	www.coursehero.com Internet Source	4%
2	Renfeng Zhao, Lei Guo, Weicheng Gao, Xudong Xiao, Yanwei Liu. "Structure Optimization Design of Screw Conveyor based on EDEM", Journal of Physics: Conference Series, 2022 Publication	4%
3	tm.spbstu.ru Internet Source	4%
4	api.inmateh.eu Internet Source	2%
5	repository.itelkom-pwt.ac.id Internet Source	1%
6	www.ars.usda.gov Internet Source	1%
7	mafiadoc.com Internet Source	1%

8

Ray Bucklin, Sid Thompson, Michael
Montross, Ali Abdel-Hadi. "Grain Storage
Systems Design", Elsevier BV, 2019

Publication

1 %

9

Submitted to Universitas Muhammadiyah
Sidoarjo

Student Paper

1 %

10

ejournal.umm.ac.id

Internet Source

1 %

Exclude quotes Off

Exclude matches < 1%

Exclude bibliography On